



Lifting Equipment Engineers Association

Guide to Documentation and Marking – Part 4 Lifting Accessories, Non-Fixed Load Lifting Attachments

Document reference LEEA 059-4 version 2 dated 23.02.15

Introduction.

This guide is aimed at manufacturers, distributors and users of lifting equipment within the European Economic Area. It has been developed as a quick reference guide to ensure that lifting equipment is supplied with the correct documentation and marking as required by current legislation, standards and best practice guidance.

LEEA 059-4 is one of a series of guides related to documentation and marking of a range of generic forms of lifting equipment as listed below:

- Part 1 – Manual Lifting Machines
- Part 2 – Powered Lifting Machines
- Part 3 – Lifting Machine Supporting Structures
- Part 4 – Lifting Accessories, Non-fixed load lifting attachments.
- Part 5 – Lifting Accessories, Slings
- Part 6 – General accessories and Components for slings.

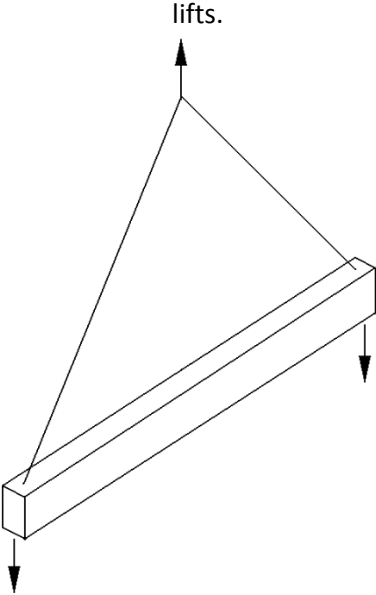
Item & Standard	Required Information
<p data-bbox="203 292 593 355">Lifting Beams , Spreaders & Frames</p> <p data-bbox="219 371 577 483">Usually designed for a specific purpose or as general purpose beams for a range of specified lifts.</p>  <p data-bbox="288 1114 506 1142">Spreader Beam</p>	<p data-bbox="636 292 1888 320">Documents to be supplied in accordance with the relevant legislation & relevant standard:</p> <ul data-bbox="683 371 1559 432" style="list-style-type: none"> - EC Declaration of Conformity (guidance LEEA 030.1e) - Manufacturer’s instructions for use. (guidance LEEA SI.8.3) <p data-bbox="636 475 943 504">Marking requirements</p> <ul data-bbox="683 555 1417 751" style="list-style-type: none"> - CE Mark - Business name and address of the manufacturer. - Serial number. - Year of construction. - Total mass of the assembly. - Maximum working load in tonnes or kilograms. <p data-bbox="636 794 1845 823">Information Which Should Be Exchanged Between the User & the Designer or Supplier</p> <p data-bbox="636 831 2033 895">The following is the minimum amount of information which should be exchanged between the user and designer or supplier of a lifting beam, spreader or frame:</p> <ul data-bbox="683 906 2033 1374" style="list-style-type: none"> - The reason for using a lifting beam instead of other methods of handling the load. - The total maximum weight of the load to be lifted together with any other forces which may be superimposed on the load. - A detailed description or drawing of the load to be lifted together with principal dimensions which affect the lifting operation including information on the position of the centre of gravity and available headroom. - Details of external obstructions to the use of the beam or spreader. Attention is drawn to the fact that a lifting beam could foul the structure of a double beam crane before the upper limit is reached. - The exact type, dimensions and capacity of the crane hook and safe working load of the crane. Particular attention should be paid to the safety catch fittings and guards. - The speed and duty rating of the crane. - Frequency of use. - Environmental considerations such as extremes of temperature or corrosive atmospheres. - The level of operatives’ skill and ergonomic considerations. It should be made clear if the beam is to

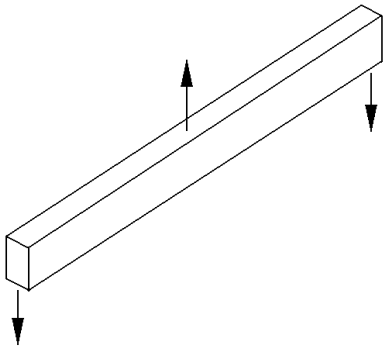

Lifting Beam

BSEN 13155

LEEA COPSULE- Section 21

be used by unskilled labour or if the design of the lifting operation requires the attention of a skilled fitter. If manipulation of the beam is necessary in order to carry out the lift then the labour availability and requirements should be specified.

- Operating assembly and storage instructions.
- Any additional tests required by the purchaser.
- The weight of the lifting beam.

Plate Lifting Clamp

Used mainly in the steel fabrication industry for attaching to plate metals allowing them to be manoeuvred.

Documents to be supplied in accordance with the relevant legislation & relevant standard:

- **EC Declaration of Conformity (guidance LEEA 030.1e)**
- **Manufacturer's instructions for use. (guidance LEEA SI.9.4 and SI.10.3)**

Marking requirements

- **CE Mark**
- **Business name and full address of the manufacturer**
- **Designation of the machinery**
- **Identification mark**
- **Weight of unloaded attachment, when it exceeds 5% of the WLL of the equipment or 50kg, whichever the less**
- **Year of manufacture**
- **Safe working load (minimum and maximum)**
- **Permissible gripping range**

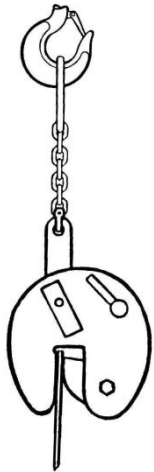

Type (1) Plate Clamp



Type (2) Plate Clamps

Type (1) additional marking

- Range of safe working load in straight pull and, where applicable, also at an angle to the side plate of the clamp, specifying the angle.
- Range of plate thickness permitted.

Type (2) - Permanently attached to sling, additional marking

- Safe working load as an assembly.
- Range of plate thickness permitted.

Type (2) - Loose clamps, additional marking

- Safe working load per pair.
- Range of plate thickness permitted.
- Angle of use and method of reeving ie two leg or endless loop

Information Which Should Be Exchanged Between the User & the Designer or Supplier

Plate clamps are widely used, particularly in the steel fabrication industry, for handling a variety of work including individual pieces of plate, fabricated assemblies and bundles of plates. The term covers several designs which fall into two basic types:

Type (1) – Clamps which grip the edge of the plate by friction. These are subdivided into those used to lift the plate in the vertical position only and those which lift from the horizontal to the vertical or vice-versa.

Type (2) – Clamps designed to lift the plate in a horizontal position only, when used in conjunction with a two leg sling or reeved onto an endless loop, according to design.

Information for types 1 and 2

- (1) Thickness or range of plates to be handled.
- (2) Longest length and greatest width of plate to be handled.

<p style="text-align: center;">BS EN 13155</p> <p>LEEA COPSULE- Section 22</p>	<p>(3) Maximum and minimum weight to be lifted.</p> <p>(4) Effective section of crane hook on which the clamp or clamp sling is to be used.</p> <p>(5) Whether the clamp is to be used to handle plates:</p> <p>(a) Horizontally only.</p> <p>(b) Vertically only.</p> <p>(c) Horizontal to vertical through 90° only.</p> <p>(d) Horizontal to horizontal through 180°.</p> <p>(e) At an angle to the plane of the clamp side plates.</p> <p>(6) Material of plate and hardness if other than mild steel.</p> <p>(7) If the plate is polished.</p> <p>(8) If slight marking of the plate is any detriment.</p> <p>(9) Details of any adverse conditions eg handling hot plates, acidic environment.</p> <p>(10) The amount of headroom available.</p> <p>(11) Thickness of any spacers or packing in between plates when stacked which may limit access for the clamp.</p> <p>(12) Details of any additional tests required.</p> <p>(13) Any special operating instructions.</p> <p>Additionally for Type (2) Only In addition to the above:</p> <ol style="list-style-type: none"> 1. Maximum number of plates to be lifted at one time. 2. If the clamps are to be supplied complete with sling or if not the type and length of sling to be used.
<p style="text-align: center;">Barrel Lifters</p> <p>A specialised lifting accessory which, when used with a lifting machine will lift a barrel and manipulate it whilst suspended (If fitted with the correct mechanism)</p>	<p>Documents to be supplied in accordance with the relevant legislation & relevant standard:</p> <ul style="list-style-type: none"> - EC Declaration of Conformity (guidance LEEA 030.1e) - Manufacturer's instructions for use. <p>Marking requirements</p> <ul style="list-style-type: none"> - CE mark - Business name and address of the manufacturer - Designation of the machinery

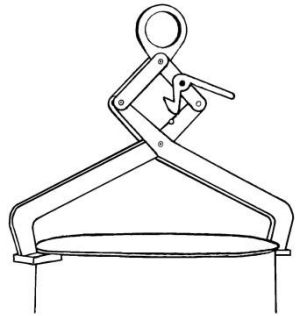

Scissor type Lifter

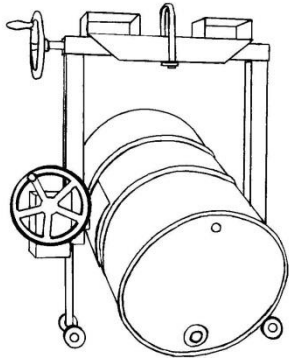

Adjustable / rotating type

**BS EN 13155
LEEA COPSULE – Section 24**

Crane Forks

A device used in conjunction with a crane or other lifting machine to lift palletised loads of the type more normally associated with fork lift trucks

- **Identification mark**
- **Weight of unloaded attachment, when it exceeds 5% of the WLL of the equipment or 50kg, whichever the less**
- **Year of manufacture**
- **Safe working load (minimum and maximum)**
- **Permissible grabbing range**

Information Which Should Be Exchanged Between the User & the Designer or Supplier

Barrel lifters are normally used for closely defined applications. It is therefore usually possible to give the designer or supplier precise details of the task to be performed. This information should include, but is not necessarily limited to, the following:

1. The gross barrel weight to be lifted.
2. The material and composition of the barrel to be lifted, eg steel or plastic.
3. The physical dimensions and the shape of the barrel to be lifted and position of the centre of gravity.
4. The 'make up' of the load to be lifted, eg a liquid, powder or granules.
5. The method of attachment to the barrel, eg scissor action, screw clamp.
6. If the barrel is to be manipulated, the axis and extent of rotation required and method of manipulation.
7. The number, shape and orientation of the gripping pads.
8. The detail of the operating environment and service conditions, ie extremes of temperature, probability of shock loading and the uncertainty of the mass of the load.
9. The available headroom.
10. The type of suspension.
11. The speed of the hoisting mechanism.
12. Details of any possible surface contamination as this may be damaging to the material from which any gripping pads are made and may affect their ability to grip the barrel.

Documents to be supplied in accordance with the relevant legislation & relevant standard:

- **EC Declaration of Conformity (guidance LEEA 030.1e)**
- **Manufacturer's instructions for use.**

Marking requirements

- **CE mark**

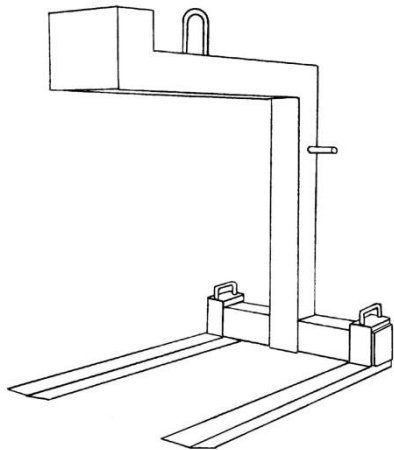

Counter balanced crane fork

**BS EN 13155
LEEA COPSULE – Section 25**

- **Business name and address of the manufacturer**
- **Designation of the machinery**
- **Identification mark**
- **Weight of unloaded attachment, when it exceeds 5% of the WLL of the equipment or 50kg, whichever the less**
- **Year of manufacture**
- **Safe working load (minimum and maximum)**
- **Permissible grabbing range**
- **The limits of the intended position of the load centre of gravity**
- **Where a minimum load is required to tilt the fork in accordance with EN 13155 clause 5.2.5.2, the minimum load must be displayed.**

Information Which Should Be Exchanged Between the User & the Designer or Supplier

Crane forks may be used for specific applications or for a variety of similar applications. It is therefore usually possible to give the designer or supplier precise or general details of the tasks to be performed.

This information should include but is not necessarily limited to the following:

1. The minimum and maximum mass of the load to be lifted.
2. The size and type of pallet to be lifted or, if self palletised, the position of the fork arm apertures and method of securing the load elements eg banding, wrapping.
3. The physical dimensions and shape of the load to be lifted.
4. The make up of the load to be lifted, ie a single object or multiple objects, and if multiple, the method of securing them, eg building blocks secured by shrink wrap.
5. The type of suspension, ie fixed, manual or automatic adjustment.
6. The available headroom.
7. The control features required, eg grab handles.
8. Details of the operating environment and service conditions, eg extremes of temperature, probability of shock loading, uncertainty of mass of the load.
9. Other safety features required, eg secondary positive holding device.

Magnetic Lifters

Designed to lift specific magnetic materials. Not usually

Documents to be supplied in accordance with the relevant legislation & relevant standard:

- **EC Declaration of Conformity (guidance LEEA 030.1e)**
- **Manufacturer’s instructions for use.**

designed for general lifting.
Four main types: Battery fed
electric lifting magnets, Mains
fed electric lifting magnet,
Permanent lifting magnet,
Electro permanent lifting
magnet

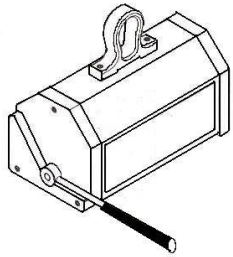

Portable permanent magnet

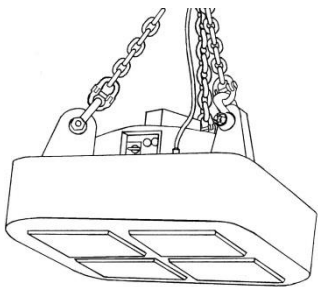

Electro-permanent magnet

BS EN 13155
LEEA COPSULE – Section 26

Marking requirements

- **CE mark**
- **Business name and address of the manufacturer**
- **Designation of the machinery**
- **Identification mark**
- **Weight of unloaded attachment, when it exceeds 5% of the WLL of the equipment or 50kg, whichever the less**
- **Year of manufacture**
- **Safe working load (minimum and maximum)**

Note: In the case of magnets, the lifting capacity depends, amongst other things, upon the material of the load, its thickness and surface, and the air gap between the load and the magnet. It is therefore recommended to state the maximum permissible loading as a function of the various parameters. However, it shall be recognized that the lifting capacity does not depend solely upon the magnetic forces but also can be limited by the lifting capacity of the suspension.

Information Which Should Be Exchanged Between the User & the Designer or Supplier

It is strongly recommended that as much detail as possible about the application(s) is given to the manufacturer or supplier. If the magnetic lifter is for a specific application, it is usually possible to provide precise details of the task to be performed. For general purpose use such as handling a variety of steel stock in a machine shop, the information may have to be restricted to a selection of typical examples. The information should include but is not necessarily limited to the following:

1. Mass of the load to be lifted.
2. Material of the load to be lifted, eg grade of steel, and the surface finish.
3. Shape and dimensions of the load to be lifted.
4. The structure of the load to be lifted eg a single slab, bundle or multiple sheets.
5. Details of the lifting operation including, height, travel and whether load shedding is required.
6. Characteristics of the lifting machine including the hoisting speed, travel speeds and headroom.
7. Method of connection to the lifting machine.
8. Availability of electrical supply if appropriate.
9. The control mechanism required, ie manual, power, integrated or remote.
10. The control features required eg load shedding.

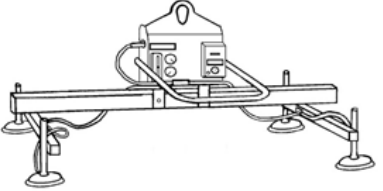
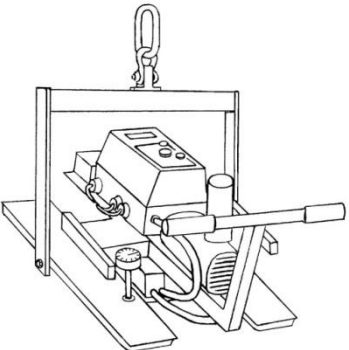
	<p>11. Backup and other safety features required.</p> <p>12. Details of the operating environment and service conditions eg extremes of temperature, probability of shock loading, uncertainty of mass of the load, whether persons can quickly leave the danger zone.</p>
<p>Vacuum Lifters Uses a vacuum to lift a specific load. Not usually designed for general lifting. Four main types: Self actuating, Mechanically pumped, Venturi and Turbine.</p>  <p>Multi-pad vacuum lifter</p>  <p>Vacuum lifter with integral vacuum pump</p>	<p>Documents to be supplied in accordance with the relevant legislation & relevant standard:</p> <ul style="list-style-type: none"> - EC Declaration of Conformity (guidance LEEA 030.1e) - Manufacturer’s instructions for use. <p>Marking requirements:</p> <ul style="list-style-type: none"> - CE mark - Business name and address of the manufacturer - Designation of the machinery - Identification mark - Weight of unloaded attachment, when it exceeds 5% of the WLL of the equipment or 50kg, whichever the less - Year of manufacture - Safe working load (minimum and maximum) <p>Information Which Should Be Exchanged Between the User & the Designer or Supplier It is strongly recommended that as much detail as possible about the application(s) is given to the manufacturer or supplier. Vacuum lifters are normally used for closely defined applications. It is therefore usually possible to give the designer or supplier precise details of the task to be performed. This information should include but is not necessarily limited to the following:</p> <ol style="list-style-type: none"> 1. The mass of the load to be lifted 2. The material and composition of the load to be lifted, eg surface finish and porosity. 3. The physical dimensions and shape of the load to be lifted and location of the centre of gravity. 4. The “make up” of the load to be lifted eg a single slabs, packages, boxes etc. 5. The number, shape and orientation of the lifting pads. 6. Details of the operating environment and service conditions eg extremes of temperature, probability of shock loading, uncertainty of mass of the load.

<p>EN 13155 LEEA COPSULE – Section 27</p>	<ol style="list-style-type: none">7. The available headroom.8. The type of suspension.9. The speed of the hoisting mechanism.10. Availability of electrical supply or compressed air supply if appropriate.11. The control mechanism required, that is, integrated or remote.12. Details of any possible surface contamination of the load as this may affect the material from which the pads are made.13. Back up and other safety features required.
---	---

APPENDIX 1

The following appendix has been developed as a guide to support the requirements of LEEA 059.

The relevant legislation is:

- Machinery Directive 2006/42/EC
- Supply of Machinery (Safety) Regulations 2008
- Provision and Use of Work Equipment Regulations 1998
- Lifting Operations and Lifting Equipment Regulations 1998
- Management of Health and Safety at Work Regulations 1999.

It is emphasised that this guidance applies to legal requirements only. If the equipment or service provided is to a standard or other specification, additional documents or marking may be required. For each product type within the guidance these marking requirements have been specified

Lifting equipment includes any manual or power operated lifting machine and any lifting accessory which can connect the load to the lifting machine or the lifting machine to its supporting structure.

The guiding principle for all documentation is that it must be legible, complete and accurate. Information which is untrue can result in prosecution. In particular the traditional practice of 'back to back' documentation is now unacceptable.

NEW EQUIPMENT

New lifting equipment must comply with The Supply of Machinery (Safety) Regulations 2008 as amended in 2011. (SOMSR) The Responsible Person must issue an EC Declaration of Conformity (DOC) and affix the CE marking. This document and marking are evidence that the Responsible Person has claimed compliance. The equipment must also be accompanied by instructions. The information to be contained in the EC Declaration of Conformity and the instructions and the other marking requirements are defined within the guidance for each product type.

Note: Some machinery and safety components are subject to special attestation procedures. These are listed in Annex IV of the Machinery Directive (Annex D of the Supply of Machinery (Safety) Regulations) In general, such special procedures only apply to lifting equipment if it is to be used for lifting persons.

An employer has a duty under Regulation 10 of PUWER98 to ensure that any new equipment has been designed and constructed in compliance with the essential requirements contained in SOMSR. The EC Declaration of Conformity and the CE marking are evidence that it complies.

An employer has a duty under Regulation 9 of LOLER to have lifting equipment thoroughly examined (which includes any appropriate supplementary testing) before first use. There is an exemption for new equipment if it has not been used and the employer has received an EC Declaration of Conformity made not more than 12 months before the equipment has been put into use. However if safety depends on the installation conditions, a thorough examination is required to ensure that it has been installed correctly and is safe to operate. Following any thorough examination, the person making the examination has a duty under Regulation 10 of LOLER to make a report of the examination. The information to be contained in that report is listed in LOLER Schedule 1 and LEEA have produced example templates, refer to LEEA 030.1a.

The simplest solution

In most cases, the simplest way to comply with the legal requirements is for the manufacturer to issue the EC Declaration of Conformity, affix the CE marking and provide instructions. If the equipment is not supplied direct to the end user, those in the supply chain should pass on the original documents and not alter any markings. The end user should obtain and keep the original documents. If the exemption applies, the equipment can be put into use. If, at the point of being put into use, the exemption does not apply or if safety depends on the installation conditions, the employer should have it thoroughly examined by a competent person and obtain and keep the report of that examination. Provided the report states that it is safe to operate, the equipment can be put into use.

Problems and alternative solutions

(1) Your supplier has not provided the DOC

The equipment should be rejected until it is provided.

(2) The DOC covers a bulk supply which you will sell in smaller quantities

Provide a copy to your customer. However it is likely that the exemption under LOLER will not apply so thoroughly examine the equipment and issue a LOLER report. Alternatively combine the two with a statement on the LOLER report to the effect that the Responsible Person issued a DOC for the item. Keep the DOC and let your customer see it if requested.

(3) Your supplier will sell direct to your customer so you do not wish to reveal your source

The marking requirements of SOMSR for lifting machines include the name and address of the manufacturer. For lifting accessories it includes identification of the manufacturer. You cannot therefore legally hide this information. If your supplier is not the manufacturer but has passed on the original documents, the simplest solution applies. If your supplier is the manufacturer then either use the alternative in (2) above or 'own brand' it as in (4) below.

(4) Equipment made by others but sold in your name

This is known as 'own branding'. **The Commission guidance is that if you appear to be the manufacturer you must accept all the obligations of a manufacturer including assembly of the technical file, declaration of conformity, marking and compliance with the essential safety requirements.** If you are not in possession of the technical file you should have a written mandate from the manufacturer that authorises you as their legal representative and details explicitly which obligations set out in article 5 are entrusted to you. As a minimum you must be made responsible for compiling the technical file and making it available to the authorities if requested during market surveillance.

Note: The technical file needn't be paper based, electronic records are acceptable and only a Member State can expect to have sight of it following a substantiated request.

(5) Equipment assembled from several items or modified

The person assembling equipment is regarded as the manufacturer of the assembly. If items within the assembly have a DOC, that forms part of the technical file for the assembly. Similarly anyone modifying equipment and/or changing its intended use is regarded as the real manufacturer. In both cases the obligations include assembly of the technical file, issuing of the DOC, marking and compliance with the essential requirements including provision of instructions.

(6) Equipment made by others which you are asked to test and certify

Be cautious about what you are being asked to do. Traditionally a certificate of test and examination was all that was required to take the equipment into service. Now it is only one ingredient of the technical file. If you are testing it on behalf of the manufacturer as part of his verification process, then he should provide a test specification for you to work to after which you should simply report the results. However some internet sources do not provide any documentation and customers will send such equipment or home made equipment expecting you to

test it and certify it as safe to use. In general, equipment which should be CE marked and have a DOC but hasn't, should be referred back to the manufacturer. If you go beyond simply testing, examining and reporting the results, you may be taking a risk.

If it is a test and examination of a new installation and safety depends upon the installation conditions, then Regulation 9 of LOLER applies. Check also that your customer has the DOC(s) from the manufacturer(s) and that the equipment has been installed in accordance with their instructions. If it is an assembly of items or includes a modified item, check who is responsible for the assembly or modification. See (5) above.

(7) Equipment supplied without instructions

There is a requirement under SOMSR that the equipment is accompanied by instructions for use. Therefore, as a general rule, the equipment should be rejected until such instructions are supplied. If it is general purpose equipment, without any characteristics particular to the design, then generic instructions are an acceptable alternative, eg the LEEA safety information leaflets.

(8) Equipment supplied without CE marking

In general, all complete items of lifting equipment should have the CE marking. Sub assemblies and components are not usually marked. Some items, such as shackles, may be made for non-lifting applications. If the item is supplied complete, intended for lifting applications and not marked, reject it.

(9) Equipment with a Declaration of Incorporation

An EC Declaration of Incorporation (DOI) is a device to legally market machinery which can function but is not complete and may not be safe. It is a statement that the machinery is not to be used until incorporated into an assembly for which a DOC is issued. If you buy and incorporate such machinery, you have the obligations of the manufacturer of the finished assembly.

IN-SERVICE EQUIPMENT

An employer has a duty under Regulation 9 of LOLER to have his lifting equipment thoroughly examined at specified maximum periods or in accordance with an examination scheme and after any exceptional circumstances which are liable to jeopardise the safety of the equipment. Following any thorough examination, the person making the examination has a duty under Regulation 10 of LOLER to make a report of the examination irrespective of whether or not the equipment is found safe to use.

The report must be made to the employer and any person from whom the equipment has been hired or leased. If the person making the examination is of the opinion that there is a defect involving an immediate or imminent risk of serious personal injury, he has a duty to send a copy of his report to the relevant enforcing authority. (Generally the HSE) The information to be contained in that report is listed in LOLER Schedule 1 and LEEA have produced example templates, refer to LEEA 030.1a.